

BP 4

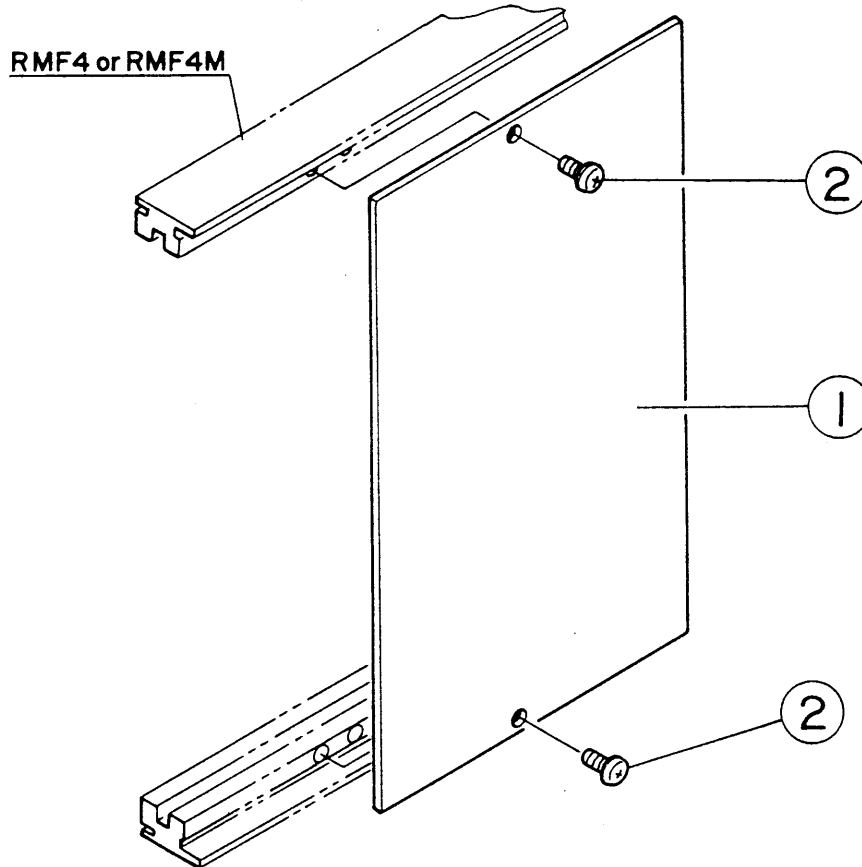

NO.	DESCRIPTION	QTY
1	BLANK PANEL BP4	1
2	SCREW WITH PW(S) M4x0.7x8 B-NI	2